

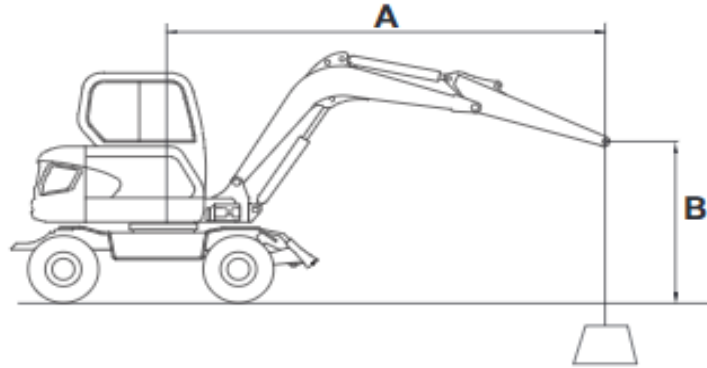

# 3.0 붐 & 1.6M 암 & 전방자세 & Dozer Up

DX65W-7















- 붐 : 3.0 m
- 암 : 1.6 m
- 버킷 : 장착 안함
- 카운터웨이트 : 364 kg
- 휠 : 싱글 휠
- 도저 : 후면 장착, 도저 상승
-  : 전방 자세
-  : 측방 또는 360 선회 자세
- 단위 : 1,000 kg

DS2200259

그림 9

METRIC

1,000 kg

A (m) \ B (m)	1		2		3		4		5		MAX. REACH			
													A (m)	
5												* 1.20	* 1.20	3.57
4							* 1.21	* 1.21				* 1.04	* 1.04	4.47
3							* 1.34	1.25				* 1.00	0.89	4.97
2					2.08	1.81	1.36	1.20	0.98	0.87	0.92	0.82	5.20	
1					1.97	1.71	1.31	1.15	0.96	0.85	0.91	0.80	5.19	
0			* 2.19	* 2.19	1.92	1.66	1.28	1.12			0.96	0.84	4.95	
-1	* 2.93	* 2.93	3.77	3.15	1.92	1.66	1.27	1.12			1.11	0.98	4.44	
-2			3.85	3.22	1.96	1.70					1.57	1.37	3.50	

# 3.0 붐 & 1.6M 암 & 전방자세 & Dozer Down

DX65W-7

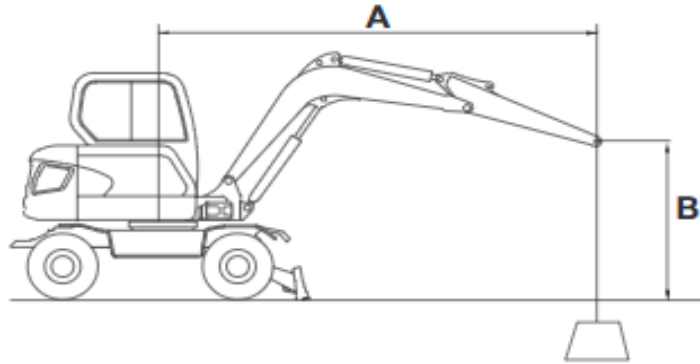

- 붐 : 3.0 m
- 암 : 1.6 m
- 버킷 : 장착 안함
- 카운터웨이트 : 364 kg
- 휠 : 싱글 휠
- 도저 : 후면 장착, 도저 하강
- : 전방 자세
- : 측방 또는 360 선회 자세
- 단위 : 1,000 kg

DS2200258

그림 10

METRIC

1,000 kg

A (m) \ B (m)	1		2		3		4		5		MAX. REACH			
													A (m)	
5												* 1.20	* 1.20	3.57
4							* 1.21	* 1.21				* 1.04	* 1.04	4.47
3							* 1.34	1.34				* 1.00	0.95	4.97
2					* 2.21	1.95	* 1.64	1.29	* 1.44	0.93		* 1.02	0.87	5.20
1					* 2.86	1.84	* 1.94	1.24	* 1.56	0.91		* 1.11	0.86	5.19
0			* 2.19	* 2.19	* 3.10	1.80	* 2.11	1.21				* 1.29	0.91	4.95
-1	* 2.93	* 2.93	* 3.95	3.46	* 3.00	1.80	* 2.06	1.20				* 1.70	1.05	4.44
-2			* 3.95	3.53	* 2.44	1.84						* 1.90	1.48	3.50